

SPIN INNOVATION

THE MAGAZINE FOR SPINNING MILLS

No. 31 09/16

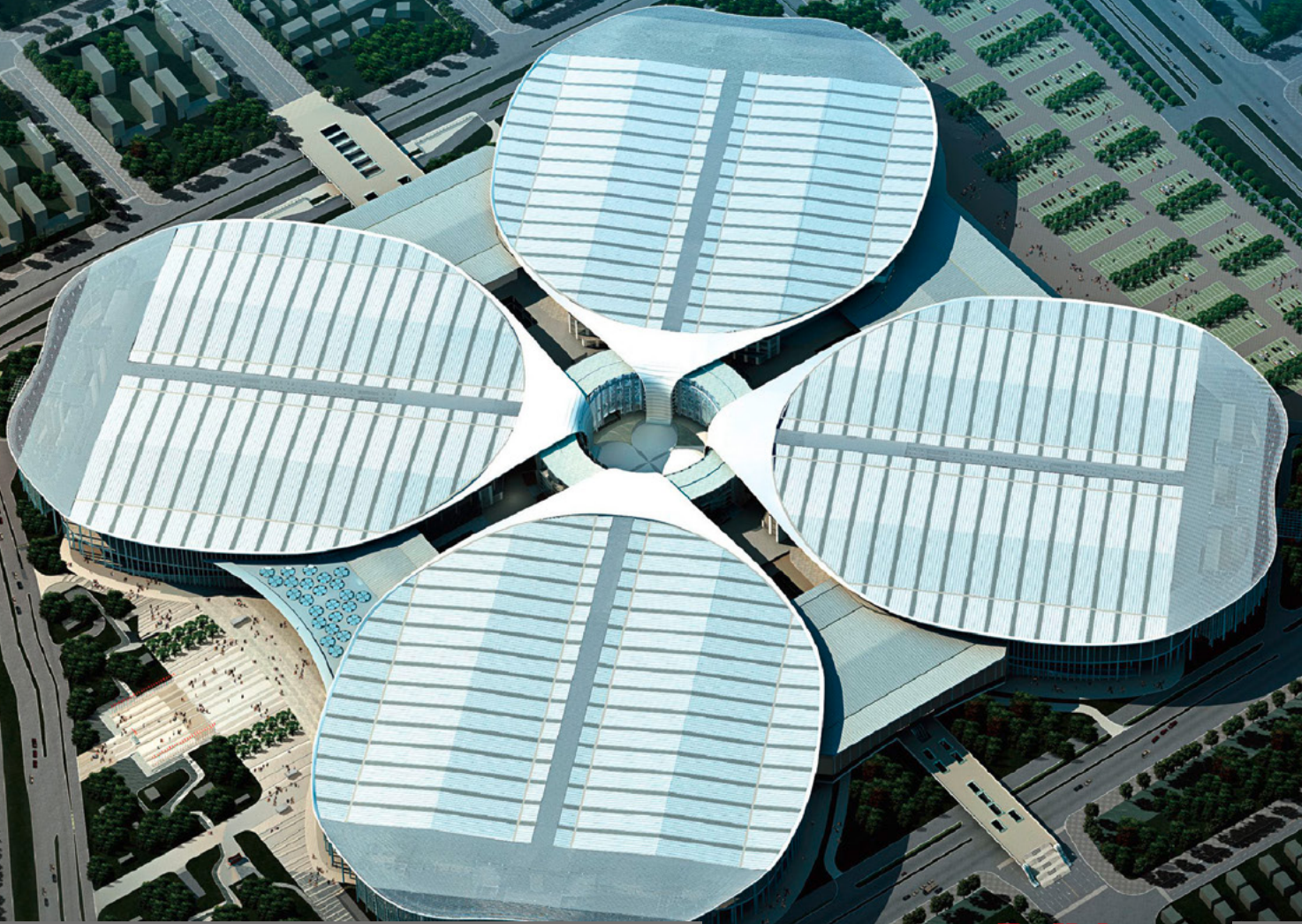

Bräcker

Novibra

Suessen

Graf

IMPRESSUM

Publication Information:

No. 31 – September 2016

SPINNOVATION

Editor in Chief: Werner Strasser
E-Mail: mail@suessen.com

Published by the 4 Companies

Bräcker

Bräcker AG, Obermattstrasse 65
8330 Pfäffikon-Zürich
Switzerland
www.bracker.ch

Novibra

Novibra Boskovice s.r.o., Na Kamenici 2188
68001 Boskovice
Czech Republic
www.novibra.com

Suessen

Spindelfabrik Suessen GmbH
Donzdorfer Strasse 4, D-73079 Süssen
Germany
www.suessen.com



Graf + Cie AG, Bildaustrasse 6
8640 Rapperswil
Switzerland
www.graf-companies.com

Title registered® at German Patent Office

Copyright © 2015

Spindelfabrik Suessen GmbH

All rights reserved

Reprint of articles with reference permitted

– Voucher copies desired

Front cover:

National Exhibition and Convention Centre,
Shanghai

Inside front page: Novibra CROCOdoff

Back cover:

Graf metallic card clothings



Werner Strasser, Head Business Group RCO
Editor in Chief SPINNOVATION

Dear Readers,

The Olympic Games in Rio de Janeiro, as well as the Copa América and the European Football Championships, are now over. All three international sporting events took place in an atmosphere of friendly competition and fair play. There were lots of winners, but what counted above all was the commitment shown by all participants.

Our products and services are also engaged in a competition every day. Our customers are the timekeepers and referees. Through their orders, they decide whether Bräcker, Graf, Novibra and Suessen come away with gold, silver or bronze! Training, team spirit, discipline and a slice of good fortune are all vital components here.

These companies are looking forward to a number of important outings in the second half of 2016. In Shanghai at ITMA Asia and in Mumbai at ITME we shall be bringing our products to the start line. Our new product developments will be competing with those of our competitors for the top spot on the podium.

However, I'd like to highlight an important difference to top-class sport. Whereas at the Olympics and Euro 2016 it was all about how you do on a particular day, we serve our customers 24 hours and 7 days per week setting new records and achievements.

Bräcker rings and travellers are in daily use and lead the way in terms of productivity and service life.

Graf clothings are successfully maintaining their position in various applications, both in the short staple and nonwoven segments.

Novibra spindles are achieving world-record speeds around the clock.

The Suessen EliTe® System is world market leader for compact spinning.

Success is the result of hard training with good teams and motivational trainers. On the following pages our teams demonstrate their top-level performance. Well-known customers again report on our products and their benefits.

I am delighted to invite you to visit us and experience our innovations.

CONTENT

EDITORIAL	3
TRENDS.....	5
FlexComb	5
The latest generation of circular combs: largest active combing surface in combination with adjustable settings in height enables our customers to achieve an even more economical combing result	
EliTe®CompactSet <i>Advanced</i> – Flip-Over Technology ..	11
STARLET<i>plus</i> - New generation of ring traveller	17
Spinning aggressive fibres is no longer limited thanks to the specific characteristics of STARLET <i>plus</i> travellers.	
Graf + Cie AG places the focus on service.....	19
New training centre at Graf Rapperswil	
MILL REPORTS	21
SANYANG TEXTILE:	21
The Largest Suessen End-User of EliTe®Compact System in China	
Aditya Birla Yarn Group, Jakarta, Indonesia.....	24
All the spinning mills under ABY group in Indonesia are users of Bräcker products – Rings and Travellers	
Bros Eastern Co., LDT, China	27
BROS EASTERN CO., LTD is a foreign-invested stock enterprise, which specializes in research & development, manufacturing and marketing of top-dyed yarn. With more than twenty years of experience, BROS now ranks in the top of the textile industry and has been listed in Shanghai Stock Exchange on June 12 th , 2012.	
Jiangsu Dasheng Group Co., Ltd., China	29
Jiangsu Dasheng Group Co., Ltd., originally named Dasheng Spinning Mill, was founded in 1895 by Mr. Zhangjian, the Number One Scholar in Qing Dynasty and also one of the most renowned entrepreneurs in early modern China.	
NEWS	31



Arnold Vetterli, Head of R & D

FlexComb

The latest generation of circular combs: largest active combing surface in combination with adjustable settings in height enables our customers to achieve an even more economical combing result

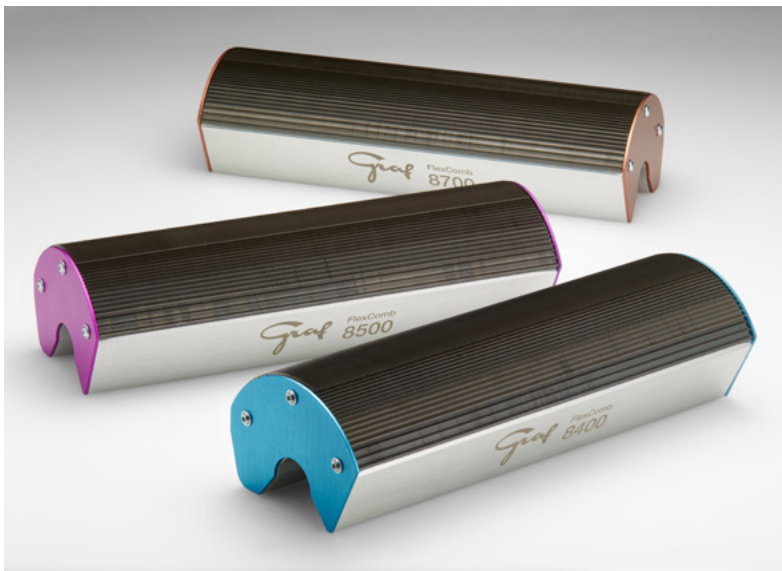

Fig. 1: FlexComb 8400, 8500 and 8700

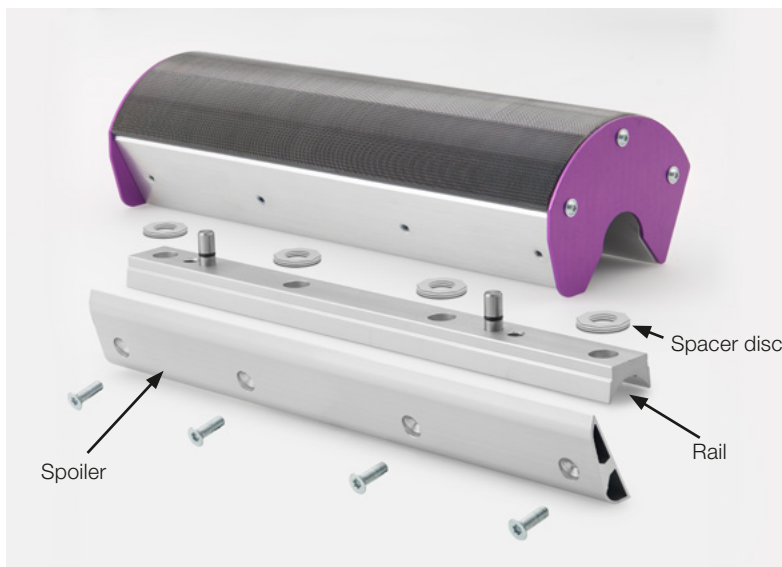

Fig. 2: FlexComb with dismantled components

Trigger for development

Latest generations of combers such as the Rieter E86 with up to 550 nips/min and production rates of up to 90 kg/h place increased and, in some cases, novel demands on our technology components. To meet our customers' demands for more economic combing results as well as the increased demands of the new combers, Graf has developed the new generation of circular combs FlexComb in cooperation with Rieter.

Phenomenon

Even though our customers are very satisfied with our existing portfolio, some expressed their desire to extend the application of the comb, particularly for special needs e.g. obtaining minimal noil. In addition a solution was sought to eliminate the differences in the distance R_{ZA} from circular comb to nipper from combing position to combing position. These variations that can be due to the tolerances in the manufacturing process of either circular comb or comb, can result in differences in noil extraction as well as in the combed sliver.

As a result of the increased nip rate of the latest comb generation additional topics which previously got little attention, i.e. aerodynamics, stiffness and inertia of the circular combs take an increasingly more important role.

Thus a new generation of circular combs for a wider range of application in combination with increased versatility but no sacrifice in quality needed to be developed.

The developed solution

To meet the challenges of our customers as well as the machinery makers Graf has devised the FlexComb, a new generation of circular combs.

The distance between circular comb and nipper can be set more easily as a result of the precise, height-adjustable system in the circular comb. Customer-specific requirements as well as local circumstances and variation in the raw material can be better taken into account and the desired result can be precisely chosen with respect to Quality, Yield and Productivity. This provides our customers with additional levers and setting options in order to achieve a maximally economical combing performance within the control loop Q, Y, P (see fig. 3).

A further feature of the FlexComb generation is the detachable spoiler which minimizes aerodynamic turbulences within the combing position and notably contributes to a substantially improved web formation at increased nip rates. For customers and applications that do not require this spoiler, it can be easily removed, leading to a further reduction in the weight of the circular comb.



Fig. 3: Positioning Performance Index P-Q-Y

The excellent interdisciplinary cooperation between development, production and technology has led to a user-friendly, weight-optimized, rigid and highly precise system. Most accurate components and the machining of the key geometries in assembled condition assure that, over the years, the system does not suffer any loss in precision and running performance despite long operating time and repeated dismantling.

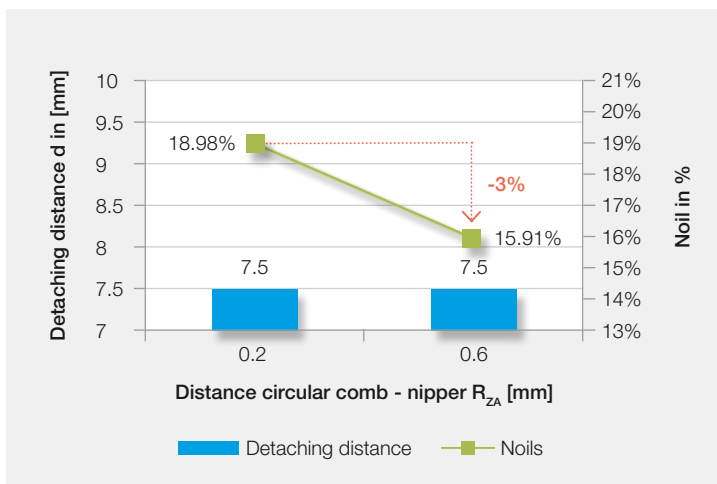

Fig. 4: Minimal noil

Precise setting of distance R_{ZA} from circular comb to nipper

The height adjustability of the FlexComb allows the distance from circular comb to nipper to be precisely set for all of the 8 combing positions. This results in an optimally even combed sliver and uniform noil at all combing positions. Fig. 5 illustrates the distances between circular comb and nipper across the 8 combing positions with conventional circular combs and those with FlexComb, set in this example to a value of 0.2 mm for this trial.

Fig. 6 illustrates a trial in which the distance between circular comb and nipper was increased in steps of 0.1 mm. In order to obtain the same amount of noil extraction at each combing position, the detaching distance 'd' had to be adjusted, meaning that with the same measurement 'd' the amount of noil extraction decreases with a higher distance between circular comb and nipper (R_{ZA}).

The circular comb can be set easily and precisely to the relevant needs by different combinations of spacer discs. The setting range of maximum 0.95 mm is carried out individually for each combing position, and,

if necessary, can even be varied within a circular comb within a small range as a result of the 4 positions that can each be set separately. Different combinations of the spacer discs supplied allow the distances between circular combs and nippers to be set from 0.10 mm to 1.05 mm in steps of 0.05 mm in a simple and straightforward manner.

R_{ZA} differences from combing position to combing position, owed to the manufacturing process can thus be compensated and with an identical setting, all combs perform in an optimal operational working range, assuring the most economic combing result.

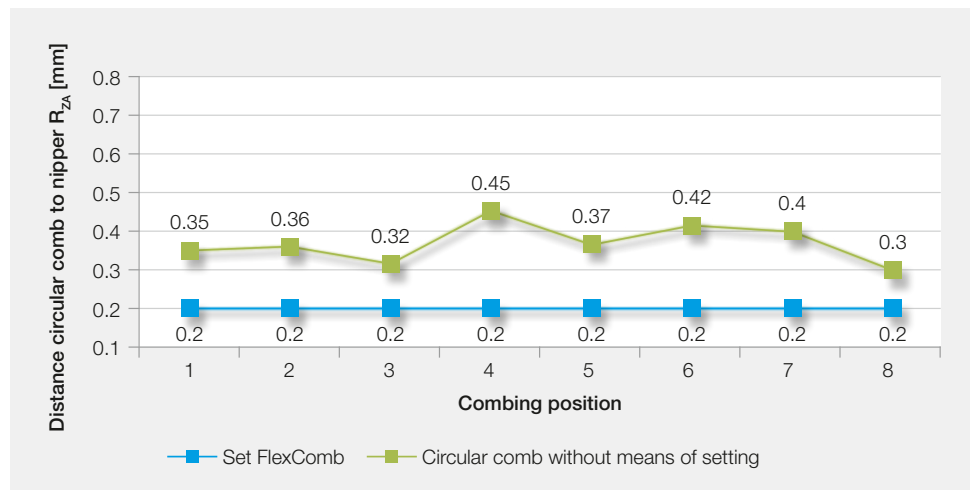

Fig. 5: Distances circular comb – nipper across all 8 combing positions

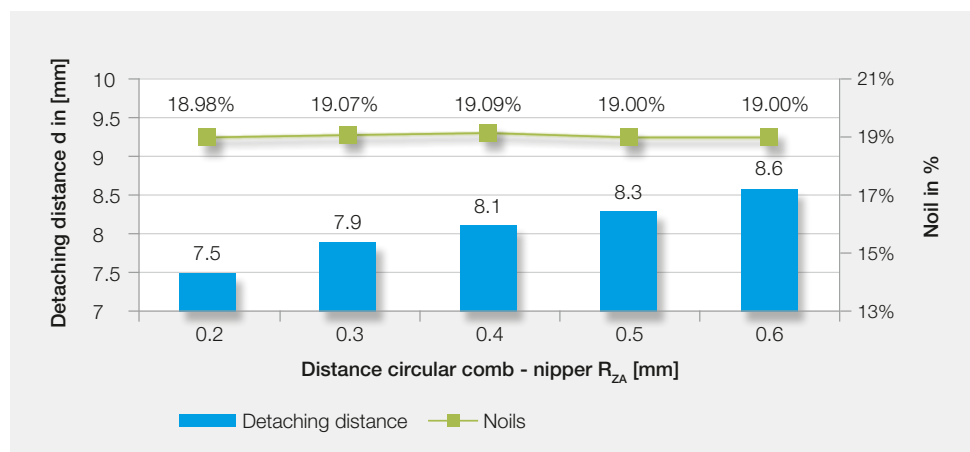

Fig. 6: Detaching distance "d" required for 19% noils with different R_{ZA}

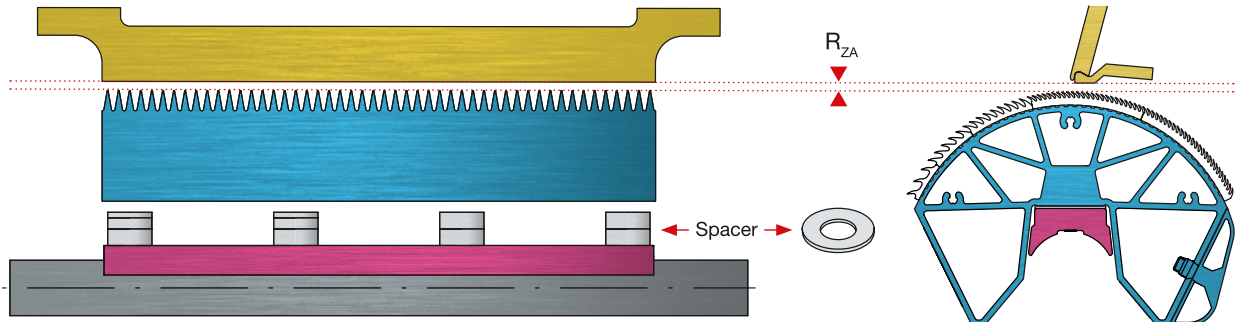

Fig. 7: Sectional view

Profile view of circular comb and nipper

Improved web formation also at highest nip rates

The increased nip rates added new demands on the aerodynamic properties. Air turbulences caused by increased speed negatively influenced the fibre fringe and the web formation, occasionally leading to inferior yarn values. To eliminate these turbulences the FlexComb is equipped with a spoiler which improves the web formation through an optimized airflow within the combing position.

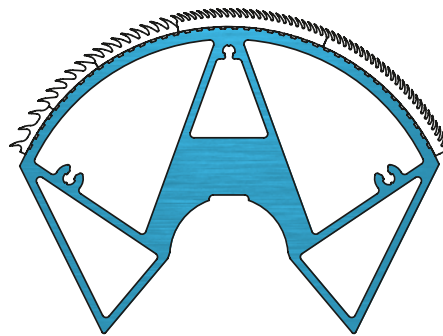

Fig. 8: Optimized geometry of FlexComb

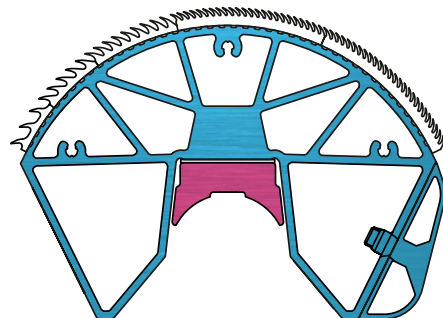

Fig. 9: Geometry of the previous version

Dynamics

Weight, inertia, stiffness

Even though the latest generation of circular combs is considerably more complex and consists of multiple components, the engineers of Graf succeeded in keeping weight and inertia nearly equal while even improving the stiffness.

As a result of the steadily increasing nip rates, the resulting forces and resonances were a further demand to this latest generation of circular combs.

By performing extensive simulations as well as elaborate field trials all demands were thoroughly taken into account during this development. The resulting light-weight, rigid and exceptionally durable product lives up to the highest requirements.

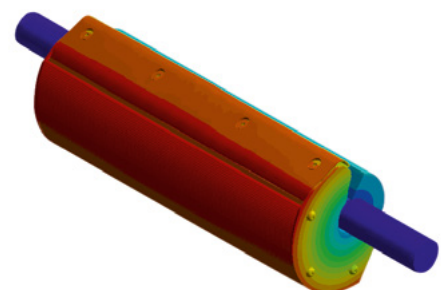

Fig. 10: 3D-FEM-simulation FlexComb

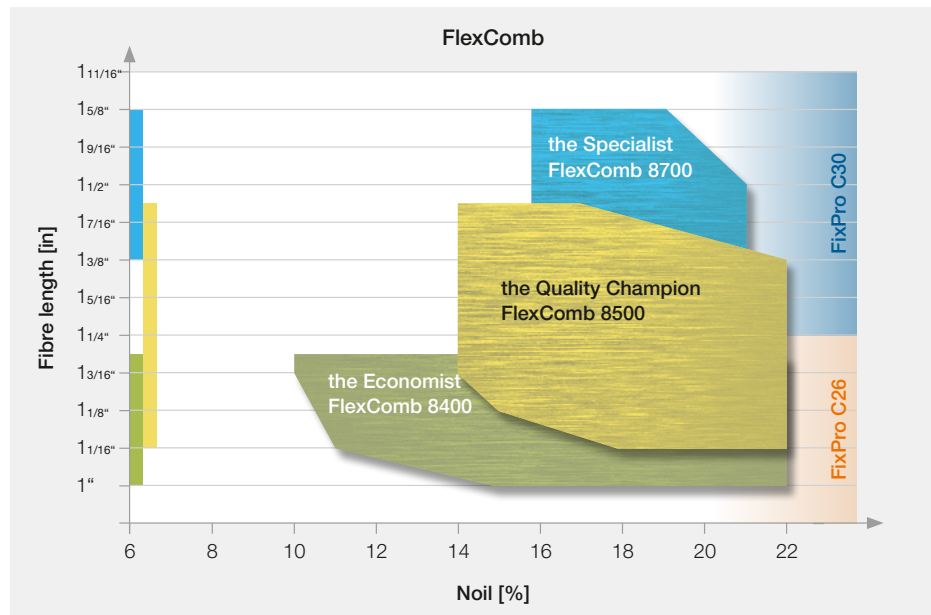

Fig. 11: Range of application of our circular and top combs for Rieter E80 and E86 combers

Ranges of application

The FlexComb generation of circular combs is for exclusive use on Rieter combers E80 and E86 and is available in three different versions:	Sections	Fibre length	Comb shaft Ø	Number of points	Working angle
FlexComb 8400 The economist: the classical application with high short-fibre content and/or high trash content for standard yarn quality.	5	25-31 mm	30 mm	~ 41800	130°
FlexComb 8500 The quality champion: Quality oriented processing of short to medium staple fibres for outstanding results in noil extraction.	5	27-37 mm	30 mm	~ 41800	130°
FlexComb 8700 The specialist: specially matched tooth geometry for gentle and efficient processing of extra-long staple fibres.	6	34-41 mm	30 mm	~ 44800	130°

For best results to be achieved with our circular combs it is essential that they are combined with top combs of equally high quality. Graf provides both key components in unrivalled quality.

Our top combs stand for highest demands on quality and the longest cleaning intervals.

Top combs of the FixPro series are available in the following versions:	Needles/cm	Fibre length mm
FixPro C26 The classical application with high short-fibre content and/or high trash content for standard yarn quality.	26	25-32
FixPro C30 Quality oriented processing of medium to long staple fibres for outstanding results.	30	32-41

Summary

The height-adjustable circular combs, FlexComb, with the largest active combing surface allow a greater versatility and an extended range of application. The adjustable settings pave the way to consider changes in the market requirements or in the raw material at any time. Furthermore a yarn quality unrivalled to date can be achieved.

Good Better Premium

Experience the difference



EliTe® CompactSet Advanced

Your compact spinning system for any application in short-staple fibre ring spinning. Join the market leader and bench mark – over 15 years of experience with EliTe® Compact Spinning Systems running on ring spinning machines of any brand and type.

www.suessen.com

Suessen

Visit us at ITMA Asia 2016
October 21 - 25
Hall 1, Booth D 01





EliTe® CompactSet *Advanced* – Flip-Over Technology

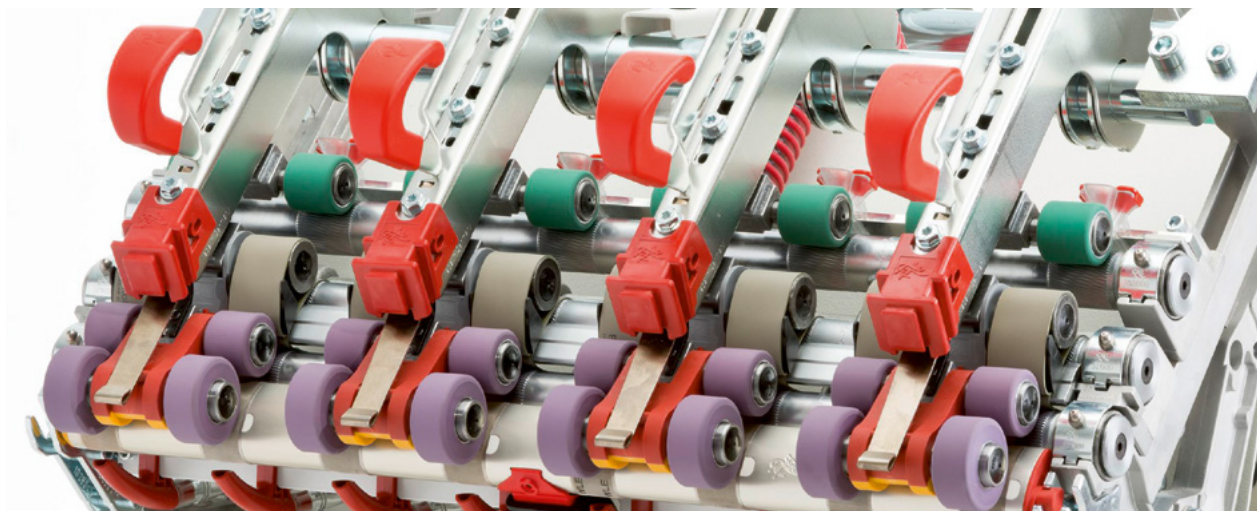

Fig. 1: EliTe® CompactSet *Advanced*

Already during ITMA Asia 2014 in Shanghai and ITMA 2015 in Milan, SUESSEN presented the EliTe® *Advanced* Compact Spinning System to the public.

In previous SPINNOVATION issues we outlined the main distinguishing and exceptional features of the concept and components.

Specifically the following criteria are the driving forces and objective targets in all of our development work for superior solutions and new product levels:

- best yarn quality achievable
- sustainable consistency in yarn quality
- increased production stability
- reduced costs for consumables
- reduced maintenance costs
- increased production
- reduced energy consumption

In this issue of SPINNOVATION we will give you a detailed insight to the specific features of the new EliTop *Advanced* with EliSpring®, EliTube *Advanced* and the Flip-Over Concept Technology.

The EliTop *Advanced* with EliSpring®

In the new EliTop *Advanced* the technique to apply the pressure to the delivery roller and the EliTe® Roller is completely different:

With the EliTop *Classic* for HP-GX, HP-A and P3-1 top weighting arms the pressure is applied by the leaf spring of the top roller weighting unit in the top weighting arm alone (Fig. 2) in accordance with the so called “stable cradle principle”. This means the applied force is divided by the structure of the EliTop body to the two top roller pairs “delivery roller” and “EliTe® Roller” in a given relation; 4/5 of the force is applied to the delivery roller, 1/5 of the force to the EliTe® Roller. This serves excellently as long as the EliTe® Compact Spinning System is combined with the solid structures of our HP-A and HP-GX top weighting arms.

Lately, more and more customers try to keep the original top arms on their ring spinning machines mainly when investment in the new machinery has not yet paid back. The inferior quality of top arms is not

so striking in conventional ring spinning. In most cases customers are not even aware of the critical quality of their top arms in use, because a competitive product has never been tested in their spinning mills.

The pressure exerted on the EliTop is not sufficient to retrieve the complete potential and benefit from our compacting system.

To compensate shortcomings for our EliTe®Compact Spinning System when customers intend to reuse their current top arm equipment in modernization projects, we now use an additional leaf spring installed at the front end of the top arm. We named this additional spring "EliSpring®".

Using EliSpring® (Fig. 2) it is not possible to apply the "stable cradle principle" anymore. In the new EliTop *Advanced* housing the pressure of the regular leaf spring of the top roller weighting unit serves to a 100 % the delivery rollers only (Fig. 3).

The EliTe®Roller receives its pressure from the new EliSpring® applying the pressure directly on top of the EliTop *Advanced* housing in the position of the EliTe®Roller.



Fig. 2: EliSpring® with EliTop *Advanced*

As explained, this new system – the EliTop *Advanced* with EliSpring® – is especially productive when inferior top arms are used in the compacting process. Our customers benefit from up to 25 % reduction in end-breaks (depending on the condition of the basic top arm), a perfect traction in driving the lattice apron on the EliTube and excellent yarn parameters with a further minimized deviation between individual spinning positions.

In future, EliTop *Advanced* with EliSpring® will be used for all top weighting arm applications (P3-1, PK, HP-GX, HP-A, etc.).

The new EliTop *Advanced* with EliTube *Advanced*

Another new feature of the EliTop *Advanced* is in the symmetry of its complete body housing. Top and bottom parts of the housing are technologically identical and only differ by their red and yellow colours to indicate "upper" and "lower" part (Fig. 4). With this design and geometry of the housing the EliTop *Advanced* can be used "upside-down". This comes into effect when the new EliTube *Advanced* and the EliTube Concepts are combined with the "flip-over technology" which we are going to describe in the following.

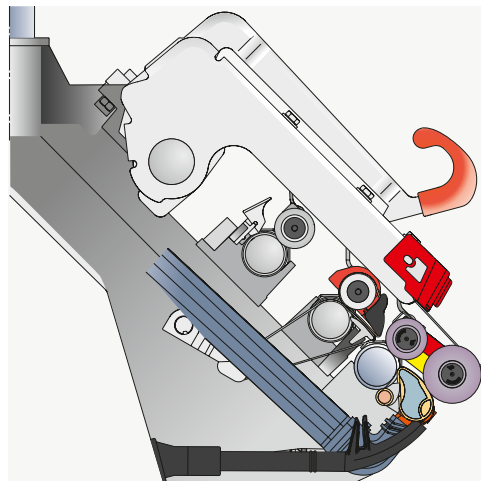

Fig. 3-: cross-section drafting system with EliTe®*Advanced*

EliTube *Advanced* and EliTube Concepts

The EliTube *Advanced* and the EliTube Concepts are the natural step ahead in the development for all new EliTe®*Advanced* projects.

The basic technological feature of EliTubes *Advanced* is the off-centred suction slot compared to the conventional spinning path (Fig. 6); the complete fibre path in the 3-roller-drafting system therefore is not anymore in the middle of the spinning position centred to the spindle tip (Fig. 7).

Thus it is possible to use all spinning components twice. As only an “off-centred” part of the component is “used” (worn out) in the spinning process, it can be “turned over” and used a second time before buffing or substitution are necessary (Fig. 8).



Fig. 4

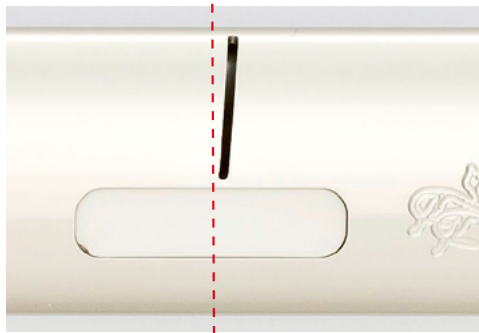

Fig. 6: off-centre suction slot on the EliTube *Advanced*

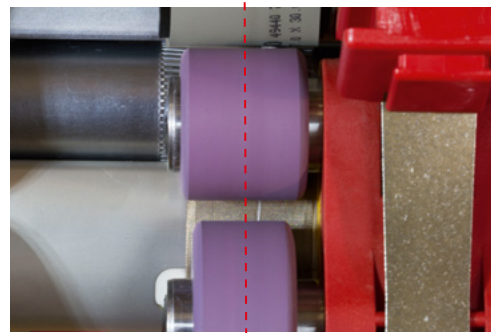

Fig. 7: off-centre suction slot visible between the cots of the EliTop *Advanced*

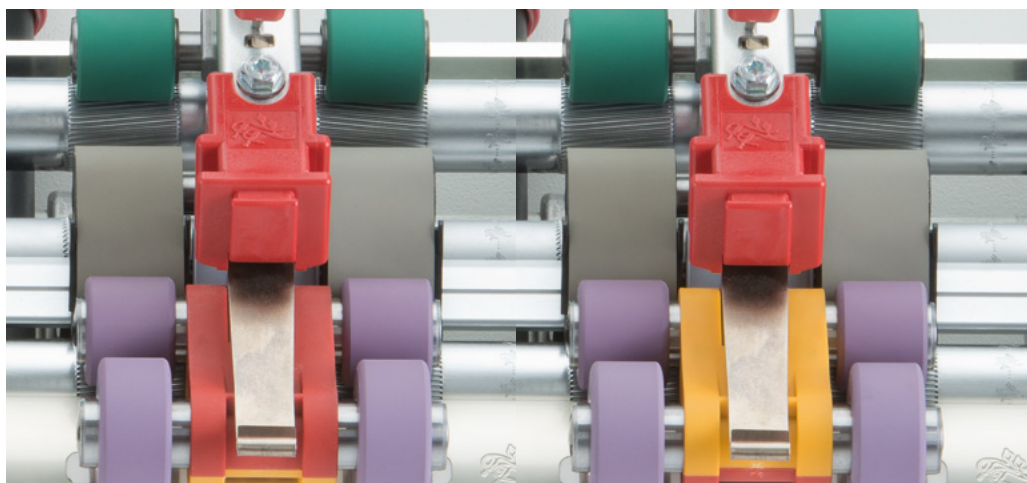

Fig. 5: “flip over” the EliTube *Advanced* within the top arm position from the “red side up” to “yellow side up”

Using EliTube *Advanced* together with EliTop *Advanced* the customer will enjoy the following advantages and benefits:

Double use of EliTop cots

When the first path on the cots is used and the worn surface should be buffed, just flip over the EliTop *Advanced* within its top weighting arm position and continue with the unused second path. This doubles lifetime of cots.

Double use of top aprons

When the first path on the top aprons is used and they should be replaced under standard spinning conditions, just turn the aprons in their position of the cradle, or exchange the left with the right apron on the cradle or vice versa. This doubles lifetime of top aprons.

Double use of back top roller cots

When the first path on the cots is used and they should be buffed, just flip over

the back top roller in its top weighting arm position and continue with the unused second path. This doubles lifetime of cots.

Extended use of lattice aprons

Lattice aprons should be cleaned at regular intervals, every 3 weeks on average. Their lifetime is up to one year depending on the fibre material spun and the yarn count. So for maintenance purposes, customers remove lattice aprons from EliTubes and refit them about 17 times within their lifetime period.

Statistical equations show that within these 17 cycles over 85 % of the lattice aprons will have changed their working direction, thus using the two different fibre paths on their surface due to the off-centred suction slots, by the ratio of at least 10 : 7 one side over the other. An overall extension of the lattice apron service life of 60 % is more than certain to be expected.

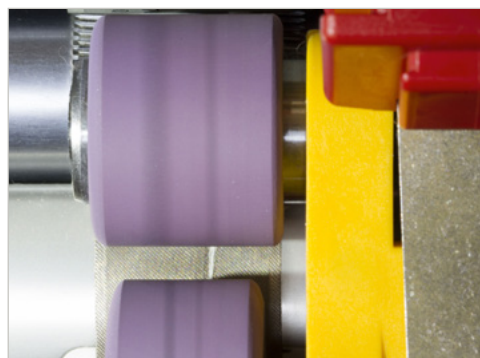
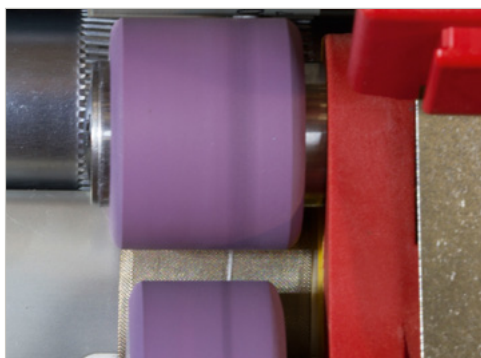

Fig. 8: double use of top roller cots in EliTop *Advanced*

Customers already using former EliTe®Compact Spinning Systems

It has been company policy from the beginning with this new compact spinning technology not to outpace those who are brave and forward looking from future developments. This principle is still valid and even more today – all new components and parts of our EliTe®Compact Spinning systems are interchangeable without much effort or additional costs for amendments to the system.

Depending on the individual requirements, customers may adapt their given systems with all or only some of the new advanced components:

EliSpring® for EliTop Classic and using inferior top arms: installing EliSpring® plus the necessary new top roller weighting unit customers benefit from increased yarn quality and reduced ends-down.

EliTube Concept: customers can get new EliTubes *Advanced* with off-centred suction slots – right-slanted slots for one, left-slanted suction slots for the other side of their ring spinning machine. Before buffing they interchange the EliTop *Classic* from one side of the machine to the other and profit from many of the benefits of EliTe®CompactSet *Advanced*.

Further benefits in using EliTop *Advanced* with the EliTube *Advanced*:

As the EliTop *Advanced* can be turned over (flipped over) in the top weighting arm and remains in the same spinning position the logistical effort is minimized.

The basic setting of the components of a spinning position such as alignment of top arm, roving guide etc. is much easier.

With EliTube Concept only one type of EliTube *Advanced* is necessary on most machines.

This all sums up in less handling and maintenance costs, as well as less expenses for consumables.

Another new feature of EliTop *Advanced* are the increased top roller cot diameters, i.e. Ø 41.35 mm for the EliTe®Roller cot and Ø 30 mm for the delivery roller cot. The customer benefits from the increased lifetime of top roller cots with an increase in utility of 165 %.



Fig. 9: EliTube *Advanced*

Retrofit EliTop *Advanced* housing plus EliSpring® with EliTube *Advanced*:

With the new housing it is not necessary to bring the EliTop to the other machine side – you just flip it over within its position in the top arm. For updating, customers only need the two housing parts plus EliSpring – all other parts from the EliTop *Classic* as top rollers, EliGears and pins may be reused. Together with EliTube *Advanced* the status is already state-of-the-art.

The drafting arrangement in EliTe®CompactSet *Advanced* is completed by two indispensable new spinning components:

Micramics – the new insert for EliTube *Advanced* (Fig. 10)

The new Micramics insert is made of highly resistant ceramic material. The specially designed microstructure of the surface supports the general spinning stability and reduces the wear of the inside surface of lattice aprons by up to 15 %. Expected lifetime of Micramics inserts is over 10 years.

New S+ lattice apron (Fig. 11)

The new surface structure of the S+ lattice apron offers an improved wear resistance up to 20 % at the outside. The better mechanical resistance makes it even fitter for everyday life in rough spinning mill conditions.

SUMMARY

EliSpring® provides better spinning stability, improved yarn parameters and minimized deviation between individual spinning positions, particularly with inferior top arms.

EliTop *Advanced* together with EliTube *Advanced* provide numerous benefits with double use of EliTop roller cots, double use of top roller aprons, double use of back top roller cots and extended use of lattice aprons.

Micramics insert together with S+ lattice apron reduce torque on the complete drafting system and provide extended lifetime of the components.

The increased customer benefits are undoubted and can be verified in terms of money.



Fig. 10: Micramics insert



Fig. 11: S+ lattice apron



STARLET^{plus} - New generation of ring traveller

Spinning aggressive fibres is no longer limited thanks to the specific characteristics of STARLET^{plus} travellers. Processing these fibres can lead to cutting marks in the yarn path of standard travellers. The time for such cutting marks to appear, sets the bench mark for the traveller quality regarding hairiness and neps of the yarn.

The latest trend to synthetic fibre production such as Viscose, PES or dyed fibres places high demands on the manufacturers of technological components. The increase of synthetic fibre production as well as the demand of higher service life of the components without any constraint in quality has considerably influenced the market.

Abrasive wear at yarn/traveller passage

In the field of synthetic yarn production one heavily affected technological component is the ring traveller which is, besides the conventional ring/traveller wear, strongly compromised by the chemical aggression of the fibres at the yarn passage. When compared to the «state of the art» wear occurring at the ring/traveller contact area, the manufacturing of synthetic yarn has brought to light a new aspect of the wear mechanisms which demands new solutions in order to meet the requirements of the customers. Figure 1 shows an example of the abrasive wear of synthetic fibres like Viscose on a STARLET traveller with a characteristic notch formation at the yarn/traveller passage.



Figure 1:
Abrasive wear at yarn/traveller passage

Analysis of the individual wear mechanisms

Starting from this motivation, Bräcker is constantly focused on the optimization and adaption of the components to the needs. Besides the permanent exchange of experience and knowledge between product application, research and development as well as production which is a mainstay of the company, Bräcker permanently evaluates the latest technologies in research and development. With regard to the «synthetic fibre issue» a unique accelerated lifetime tester has been designed and built, which allows the simulation of the wear phenomena at the traveller/yarn interface.

Applying realistic spinning parameters enables an extremely precise analysis of the individual wear mechanisms as a function of the traveller finish and the yarn parameters; respectively. Subsequent optimization of the components enables to significantly reduce the abrasive wear of the components in order to fulfil the requirements that are in precise accordance with the demands from product application.

In view of the current situation an established traveller surface finish, which is also known as STARLET has been optimized. Any intervention into an established processing route has to be in good accordance with the production department, where the realization of high volume manufacturing takes place. Therefore well documented investigations have been performed in order to ensure process reliability as well as enhanced performance of the travellers against the aggressive character of the synthetic fibres.

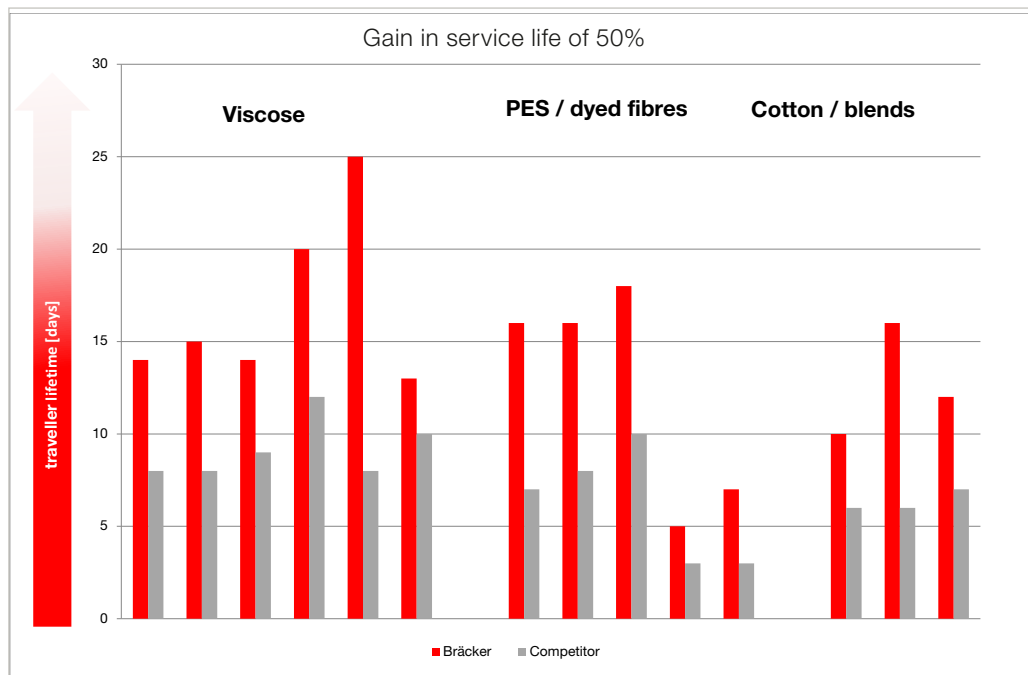

Figure 2: Traveller service life of STARLET^{plus} compared to competitor products for different spinning parameters Ne 30/1 - 40/1; 17,000 - 18,000 rpm

STARLET^{plus} - the traveller for challenging spinning conditions

The latest novelty of Bräcker regarding the described limitations is the STARLET^{plus} traveller which shows high potential due to enhanced life in various spinning mill trials performed in different countries.

Figure 2 shows the lifetime of STARLET^{plus} traveller in direct comparison to competitor's product for various fibre materials, fibre counts as well as spindle speeds. The significant gain in traveller service life proves that STARLET^{plus} offers high potential for high performance application.

STARLET^{plus} – the traveller for challenging spinning conditions



Our new product was launched successfully at ITMA 2015, ensuring long-term profits and solution for synthetic fibres with chemical aggressive characteristics. Precise selection of the surface treatments combined with high quality control enables the production of premium components which are indispensable for the production of high quality products.



Jörg Brodermanns, Head Technical Sales

Graf + Cie AG places the focus on service

New training centre at Graf Rapperswil

To train employees, customers and service partners on the current level of technology is just as important as the quality of the products. Therefore Graf continuously strives to extend this standard. The newly opened training centre in Rapperswil is thus a clear commitment to reinforce the quality of service and training.

With the application of Graf products the customers can concentrate on their core activity and enjoy advantages such as long service life or maximum fibre yield. Graf customers can thus rely on the highest quality standards, sustainable and sound performance according to DIN EN ISO 9001:2015 certification, the integrated quality control throughout all steps of production as well as process reliability by high vertical integration. These customers not only enjoy the comprehensive product portfolio of Graf. The proximity of our technical consultants and the global distribution and service network also create an important basis of trust for our clientele.

Addressing individual customer requirements is one of our outstanding strengths. Graf is familiar with each production step in detail and is in a position to provide, beside the standard products, individual solutions, which, where required, can be developed in close cooperation with interested partners.

Particularly in case of the qualitative dimensions the deciding factor for the service quality in the market is, beside the on-site customer service, the continuous further training of employees, distribution partners and customers. Specific trainings assure that employees identify with the products and are motivated to actively contribute to the further development and improvement.

Graf disposes of a global service network with a total of 21 service centres in the main textile areas of the world. Thus Graf is in a position to guarantee the customers and partners quick reaction time in case of new installations, for maintenance and service work and in emergencies.



Together with partners Graf develops service equipment that ensures the maintenance and precision of reclothings and the regular service on customers' production facilities.

The handling of this service equipment needs to be trained. For this purpose Graf offers customized instruction and commissioning courses. These trainings take place either at customer's site or else in our own training facility in Rapperswil.

The Graf service technicians act as an important interface for the customers' technical personnel. They do not only carry out the training on the use of the service equipment for the employees but also provide active advice to assure a consistent quality in service. In addition to regular workshops for customers all over the globe it is also important to train our employees to the latest state of technology.

Specifically for this purpose our existing service and training centre was relocated to a new and bigger area in the beginning of 2016. We can now offer a modern working and training facility, equipped with all service machines and a complete infrastructure for instruction courses for our service engineers, partners and customers. There is sufficient space for two new cards in the same room.

The Rieter C70 and Trützschler TC11 cards complete the possibility to provide training in maintenance, to actively address resolutions to problems and carry out instruction courses professionally. These cards are also used for the testing and further development of new service equipment.

Already in March 2016 an initial training course for our agent in Pakistan took place. Six members of staff had the opportunity to deepen their knowledge on the refinement of a flat service and the related settings on the card for several days.

Conclusion

Whether it is the technical advice, quick reaction time in case of an emergency or the training of customers and service staff, a common denominator is clearly evident: comprehensive, high-quality service in combination with leading products is the key and the primary objective of Graf in order to strengthen partners and customers in their markets.





John Yu
Senior Sales Manager

SANYANG TEXTILE:

The Largest Suessen End-User of EliTe® Compact System in China



Contact:

Sanyang Textile Co Ltd
58 Yong Shen Road
Lijin County, Dongying City
257400 SHANDONG
CHINA

Fax: +865465368001

Phone: +865465368006

Website: www.sanyanggroup.com



Mr. Xu Jianmin, General Manager of Sanyang Textile

February 14, 2015, was an unforgettable day for both Sanyang Textile and Suessen Germany, on which the two companies joined hand-in-hand and signed the great contract about the huge project of conversion of the existing 170,000 conventional spindles into EliTe® Compact.

Mr. Ioannis Spiridopolus on behalf of Suessen, Mr. Xu Jianmin, the GM on behalf of Sanyang Textile, and Ms. Lynn, Suessen Agent, were witnessing the great moment.

Sanyang Textile is one of the targets and ideal customers that Suessen pursued.

Sanyang Textile Co., Ltd., well-known in textile industry worldwide, is located in Lijin county Shandong province PRC, and was established in 2003. With continuous and firm development in the past decade, Sanyang Textile boasts half-million compact spindles, about 400 sets of advanced air-jet looms and 300 sets of two-for-one twisting machines from Germany now.

Sanyang Textile emphasizes on pure cotton spinning and weaving, and has a yarn output of 30,000 tons each year, and cotton fabric capacity of 40 million meter per year. In 2015, Sanyang had won the honor of TOP 20 most competitive enterprises in China Textile Industry for the 7th consecutive year. In 2013, Sanyang was conferred by China's State Administration for Commerce and Industry the honorary title of Famous Chinese Trademark.

Mr. Xu Jianmin, the General Manager of Sanyang Textile, has expressed that high-quality production starts with the selection of most premium raw material, advanced equipment and latest production technology.



From left to right: Mr. Bao Chuanjun Equipment Manager/ Mr. Zhu Bingzheng Purchasing Manager/ Mr. Zhang Sheng Chief Spinning Technologist



EliTe®CompactSet on Zinser 360 ring spinning frames

Mr. Xu said, in order to gear up with market expansion and rapidly increasing requirements from our customers on our products, Sanyang must invest money in purchasing new machines and equipments and raw material, this kind of investment will continue in the years to come.

The conversion of existing 170,000 conventional spindles of Zinser 360 is amongst the ambitious investment plans.

Suessen began to approach Sanyang and get the permission to participate in the competition of the conversion project in March 2014. At the beginning of 2014, Sanyang released the plan in textile industry, there were 5 local compact system suppliers participating in this project with trial machine respectively besides Suessen.

It is obvious that the competition amongst suppliers of compact system was fierce, and the trial process lasted more than half a year. As mentioned that Sanyang focused on the pure cotton combed yarns ranging from 50s to 200s, the trial included variety of yarns, it is of course a time-consuming competition.

During the competition in that half a year, Suessen system achieved convincing results, which is the foundational condition that Suessen finally won the competition.

It is very difficult to convert Zinser 360 from conventional spindles into compact because of the particularity of its structure. Nobody has dared to do this conversion in bulk on this type of machines before, but Sanyang Textile becomes the first in the world to convert 170,000 spindles of Zinser 360 in one shot. It really needs so great courage and unique vision to make the decision. The facts show that Sanyang Textile made a wise and right decision.



Chinese ring frame modified with HP-GX 3010

This is the core technology that convinces Sanyang to choose Suessen at last.

Mr. Xu Jianmin mentioned that "Sanyang has made a lot of research and trial in several months to compare the different compact systems and yarns produced on them in our own spinning workshop, and then came to a conclusion that Suessen can provide the best technology and solutions for the modification of existing 147 sets of machines, and we Sanyang will definitely benefit from it to the largest extent.

Sanyang Textile is the only enterprise in China and even the world to produce pure cotton super-finer yarns for bleaching with average yarn count 80s with all the existing compact spindles. It is also approved by China Cotton Textile Association as the only production base for premium pure cotton super-finer yarns for bleaching with guarantee. Suessen EliTe®Compact System has unique advantages without a parallel in producing super-finer yarns in terms of stability and consistency.

All the high quality super-finer yarns produced on the 170,000 compact spindles and all twisted yarns from two-for-one machines are used for yarn-dyed shirts and mercerized T-Shirts with famous brands and for high-end home textiles with famous trademarks, 70 percent of the products are exported. High quality final products request the support with high technology. Therefore, we Sanyang decided to join hands together with Suessen to manufacture premium products to our customers".

During the installation, Sanyang and Suessen carried out a one-family working principle, the perfect coordination and cooperation contribute to the smooth accomplishment of the mission. Mr. Zhu Bingzheng, the purchasing manager played an important role in putting up platform and bridge for negotiation and installation and taking over the machines after successful conversion.

Mrs. Chang Yu Hua, Production Manager, and Mr. Bao Chuan Jun, the Equipment Manager, paid a great deal of help and efforts to this mission from beginning to the end. Frankly speaking, this conversion of 170,000 compact spindles is really a huge and challenging project for Sanyang and Suessen, but everything was well organized and under control. This mission has been completed smoothly according to the strictly designed schedule in 2015. Suessen appreciates it very much.

Roland Eberhardt, the former Managing Director of Suessen Germany, expressed afterwards, "Sanyang Textile is one of the most influential enterprises in the textile industry worldwide, we are honored to cooperate with Sanyang, and we will do our best to provide first-class compact system to spinning mills. Suessen has installed more than 9 million EliTe®Compact spindles worldwide, EliTe®Compact System proved to be versatile and flexible, which is suitable for all types of ring frames".

This case is a classical model of realizing association between strong enterprises so that both sides can take advantages of each other's strength. Sanyang chose Suessen with a broad and long-term view. The facts prove that the cooperation between two sides is successful.

Sanyang and Suessen opened a second round cooperation in converting the existing top weighting arms for ring frames this year. In May 2016, Suessen has upgraded Sanyang Mill 1 with HP-GX 3010, the conversion of Mill 2 and Mill 3 is on the schedule.

We hope that Sanyang will create a prosperous future based on their good team and efficient management.

Bräcker

R. Shandheep,
Senior Sales Manager



Aditya Birla Yarn Group, Jakarta, Indonesia

All the spinning mills under ABY group in Indonesia are users of Bräcker products – Rings and Travellers



ADITYA BIRLA GROUP

Contact:

Aditya Birla Yarn Group
Menara Batavia, 16th Floor
Jl.K.H Mas Mansyur Kav.

126, Jakarta 10220, Indonesia

Phone +62 21 572 2442

Fax +62 21 572 7177

E-mail: info.aby@adityabirla.com

Website: www.adityabirla-yarn.com

Introduction

Indonesian – based synthetic spun yarn producer ABY – Aditya Birla Yarn is a well-established brand in a highly competitive market. ABY is the premium name in synthetic spun yarn production, delivering world class products for more than four decades and now accounting for 14% of global trade.

Operating at the high end of the market the Jakarta – headquartered global leader, with five manufacturing centres in the Asia Pacific region, sell some 70% of production abroad, mainly to Turkey, Brazil, Japan, Korea, Germany, Belgium, Italy, the USA and Canada. ABY enjoy a strong presence in every major textile and garment manufacturing market segment throughout the world.

“Working at the high end of the niche market, ABY is completely different from its competitors. ABY Group of mills uses the best quality raw material, produce the best quality yarn with the best machinery and accessories from Europe, Japan and the USA and are thus able to command premium prices across the world.”

ABY has been in this business for 45 years and for the past 25 years they were the undisputed leaders with a production capacity of around 147'000 tons/year.



Y.P. Sing, Joint President of PT Indo Liberty Textile Industry



N.C. Ghosh, Asst. Vice President of PT Indo Liberty Textile Industry

ABY – Aditya Birla Yarn is a grouping of five Businesses

INDONESIA

1973, PT Elegant Textile Industry
Established in 1973 with 14,080 spindles, today has a total of 174,000 spindles with 960 MVS positions.

1979, PT Sunrise Bumi Textiles
Established in 1979 with 17,250 spindles, it has now grown to a total of 102,600 spindles with 2,800 rotor spinning positions.

1995, PT Indo Liberty Textile Industry
Established in 1995 with 21,120 spindles, today the facility is equipped with 542,000 spindles, 4,440 open end rotors. Recently they completed an expansion project by adding 108,000 spindles, thus now grown to totally 182,000 spindles.



Mr. NC. Ghosh (left), Mr. YP. Sing (right)

THAILAND

1970 Indo Thai Synthetic Co. Ltd.
Established in 1970 with 12,768 spindles, the capacity has grown to 75,000 ring spindles with 6,560 open end spinning positions.

PHILIPPINES

1978, Indo Phil Textiles Mills, Inc.
Established in 1978 with 15,000 spindles, it has grown to 88,600 spindles and is equipped with worsted spinning capability.

ABY in turn is a part of the \$: 40 Billion Indian Multi National Conglomerate, Aditya Birla Group, a fortune 500 corporation with interests including viscose staple fibre, branded apparel, metals, cement, fertilizer, and financial services.

With over 130,000 employees across 42 nationalities, Aditya Birla Group has been ranked number four in the global Top Company for leader's survey and number one in Asia Pacific.

The following are statements of Mr. YP. Singh and Mr. NC. Ghosh

All the spinning mills under ABY group in Indonesia are users of Bräcker products – Rings and Travellers.

ABY group is one of the largest installations with Bräcker TITAN rings in Indonesia. The use of superior machinery and components help ABY group mills achieve superior consistency and high repeatability which makes the yarn they produce distinctive.

PT Indo Liberty Textile Industry tested the use of the new Bräcker STARLET^{plus} travellers. "We get twice the life out of these travellers as compared to the nearest competitor product", confirms Mr. YP. Singh, Joint President and Mr. NC. Ghosh, Asst. Vice President – Indo Liberty.

Performance results of the Bräcker STARLET^{plus} travellers in the mills (see below) reconfirm the statements by Mr. YP. Singh and Mr. NC. Ghosh.

The high quality of yarn lends itself perfectly well to high-quality clothing. In an industry that is highly competitive, this superior quality and added value which ABY group of mills deliver to their customers is what gives them the edge.

ABY credit their success and market leadership to their world class facilities, state-of-the-art research and development and a strong business development support.

With a vision "to be the leading producer and exporter of premium quality spun yarn globally", with a mission "to deliver superior values to customers, shareholders, employees and society at large" combined with values of integrity, commitment, passion, seamlessness and speed, Bräcker is proud to associate with ABY.

Performance results of Bräcker STARLET^{plus} travellers vs. main competitor

	Technical Data	
Traveller Type	STARLET ^{plus}	Competitor
Traveller Life	15 days	8 days
Process	100 % Rayon; den 1.2	
Fibre Length / Brand	38 mm / IBR	
Speed (rpm)	Avg. 18,000; max. 19,000	
Ring	Bräcker TITAN Inner Diameter 38 mm	
Ring Frame	Toyota RX 300	

■ Bräcker STARLET^{plus} travellers
■ Competitor travellers

Days	1	2	3	4	5	6	7	8	9	10	11	12	13	14	15
U%	9.22	9.32	9.22	9.3	9.19	9.29	9.18	9.02	9.16	9.11	9	9.1	9.12	9.13	9.12
			9.41	9.42	9.39	9.43	9.42	9.49							
IPI Value	20.8	23.2	23.1	22.9	22.4	19.3	22.9	18.7	20.1	19.6	21.4	20.1	21.5	23.2	20.3
			24.1	22.3	27.8	23.8	26.6	20.3							
Hairiness	4.62	4.72	4.6	4.58	4.52	4.57	4.62	4.67	4.51	4.6	4.67	4.7	4.52	4.59	4.62
			4.55	4.75	4.64	4.65	4.59	4.63							
End breaks	0.62				0.42				0.7			0.41		0.62	0.6
			1.46	2.38	1.64		2	1.09							

Bräcker

Kan Xuan,
Senior Sales Manager



Bros Eastern Co., LDT, China

BROS EASTERN CO., LTD is a foreign-invested stock enterprise, which specializes in research & development, manufacturing and marketing of top-dyed yarn. With more than twenty years of experience, BROS now ranks in the top of the textile industry and has been listed in Shanghai Stock Exchange on June 12th, 2012.

BROS

Contact:

Bros Eastern Co., LTD
Luo Tuo Town, ZhenHai,
NingBo, China

Phone +86 (574) 86559899

Fax +86 (574) 86264993

E-mail: broseastern@bros.com.cn

Website: www.bros.com.hk

BROS globally sources cotton and various kinds of fibres from multi-channels to ensure sufficient supply of raw material. BROS also set up subsidiaries in Zhejiang, Shandong, Hebei and Jiangsu etc. and in Vietnam with experienced production teams and excellent spinning and dyeing facilities to ensure the huge amount of 150,000 tons dyed yarn output annually. Meanwhile, BROS has established an integral marketing network on a global scale and excellent sales teams to provide the best service to customers from all over the world.

BROS yarns are sold in Europe, Asia, America, Hong Kong and China. Their clients include various famous clothing brands like UNIQLO, NIKE, GAP, H&M, POLO, ADIDAS, Li-Ning, ANTA, Semir, Meters/bonwe etc. They value creativity as the stimulation of a sustainable and healthy growth; they have actively developed various new products as well as 5500 kinds of dyed yarns which

almost cover every need of numerous cloth producers.

Besides, BROS also issues a set of colour standards every two years, and two types of popular colour standards for spring/summer and fall/winter seasons.

At the end of 2013, BROS launched the innovative and eco-friendly product - Eco-FRESH Yarn® which has been developed over 10 years. This greige dyed yarn breaks through the traditional manufacturing and dyeing processes with high-tech Environment Friendly dyeing production – “dye without salt and alkali” – extending the applicability of dyed yarn to lead in a new direction of sustainable growth.

BROS is a valuable customer of BERKOL, the equipment manager Feizhong Dong shared his experience with the fully-automatic grinding machine.



Left: Dong Feizhong, equipment manager of Bros Easton
Right: Wang Fengping, Shanghai Sanshao Int. Trading Co., Ltd., Agent of Bräcker



Left: Zhu Dingfu, grinding department supervisor
Right: Wang Fengping, Shanghai Sanshao Int. Trading Co., Ltd., Agent of Bräcker

Question: When did Bros Group begin to consider using a fully-automatic grinding machine and when did you start using the BERKOL machine?

Mr. Feizhong Dong: Bros Group attaches great importance to product quality, and we need to reduce the number of employees and to improve the efficiency. At the beginning of 2014, we have to investigate the fully-automatic grinding machine and then we introduced the BERKOL **supergrinder** in the Vietnam plant first, then one after another in Zhenhai and Huaian plant. I believe we will continue to use the BERKOL machines in the other branches and in the new projects too.

Question: How is the effect of grinding machine? Do you have some experience to share with us?

Mr. Feizhong Dong: After the two years application, we noticed the following advantages:

1. The production quality is stable. Regardless of coloured yarn or greige yarn, the yarn quality is stable after the cots grinding.
2. Cots grinding effect is excellent. The quality of the reground cots is guaranteed. Diameter, roughness degree and the size are perfect. Operators only need to test samples.
3. High production. One fully-automatic grinding machine can meet the requirement of the whole plant including ring spinning and roving. Even if we expand our production, it can also meet our needs.

4. Mechanical and electrical equipment are also stable, simple and easy to maintain. Whenever there is some small problem, the operator can fix it by himself or they get assistance by the remote guidance from Bräcker.

Question: The traditional thinking is that coloured yarn does not have high requirements on the cots, so they don't need good grinding machines. What is your opinion about it?

Mr. Feizhong Dong: This is a total misunderstanding that coloured yarn does not have high requirements on the grinding. In fact, coloured spinning and some fancy yarns have low requirements on evenness but it does not mean that their quality requirements are not high. It has a great influence on sales and customer complaints because some tests are still very strict.

In addition, for dyed spinning, it is easy to produce laps because some elements are mixed into the fibre during the dyeing process. The requirement of cots grinding is much higher than for greige yarn due to frequent lot changes.

The coloured spinning requires more labour, it is very important for us to reduce the labour costs under the premise that the quality is guaranteed, since the application of BERKOL **supergrinder**, the number of our workers in the grinding workshop decreased from 5 to 3.



Jiangsu Dasheng Group Co., Ltd., China

Jiangsu Dasheng Group Co., Ltd., originally named Dasheng Spinning Mill, was founded in 1895 by Mr. Zhangjian, the Number One Scholar in Qing Dynasty and also one of the most renowned entrepreneurs in early modern China.



Contact:
Jiangsu Dasheng Group Co., Ltd.
Jiangsu Prov., China
Phone +86 (513) 85401828
Fax +86 (513) 85544238
E-mail: gph@dasheng-group.com.cn
Website: www.dasheng-group.com.cn

Now it has 12 wholly-owned, holding and equity participation enterprises, the total assets are 2.8 billion Yuan. The current employee count is around 5000 and the retired employees are more than 10,000. The group has many kinds of industries, such as spinning, weaving, dyeing, printing, clothing, special home textiles, cultural industries, automobile sales and services. Dasheng is a national high-tech enterprise.

The textile business includes 400,000 spindles and 533 sets of weaving looms. The annual output reaches 40,000 tons of yarn and 60 million meters of grey fabrics. The special home textiles section has a capacity of 1.5 million meters of fabric, 1 million pieces of wool blankets, 30,000 pieces of wool quilts and 10,000 pieces of wool mats every year. The capacity of knitting apparel section amounts to around 600,000 suits. The products sell well in almost 50 countries and areas.

Dasheng has the first domestic full process automation, intelligent, digital cotton spinning production line in China. «Fine Count High Density Cotton Grey Fabric» and «Combed Cotton Yarn» are rewarded as «China Top Brand». Dasheng has also built a Provincial Academic Workstation, a first provincial-level textile engineering technology research centre and a new textile materials research institute of collaborative innovation. Dasheng is the owner of more than 40 patents as well.

Dasheng has been awarded the honorary titles of «National Advanced Primary Party Organization», «National Torch Program Key High-Tech enterprise», «National Textile Industry Advanced Unit», «Provincial Civilized Unit». Their sales volume, exports, profits and taxes, per capita profits and other major economic indicators of the group are among the frontrunners of the industry, and it has therefore become the national textile industry «Pacesetter Enterprise» for many years.

Question: Since when has Dasheng come to know and use Bräcker?

Mr. Zhao Zhihua: Bräcker is a world famous brand for key components. Rings, travellers, grinding machines and cots have been used for a long time. I have known Bräcker since the time of my studies at the university.

Question: What is your experience of using Bräcker products?

Mr. Zhao Zhihua: Generally speaking Bräcker products are known for their high quality, their high and stable performance and thus they are good for high speed spinning.

Rings: Dasheng has used Bräcker rings since 2008. We will constantly use Bräcker rings on our new projects, mainly when spinning all kinds of material and a very wide yarn count range, Ne32-Ne100, used on the JW1562, Toyota RX240NEW machine.

Travellers: Bräcker travellers are standard components for Siro-Compact spinning, they are high priced, but of perfect quality and excellent performance.

Grinding machine: Dasheng started using the Bräcker grinding machine in 2008 due to its high efficiency and high performance, good grinding result and to save labour cost.

Cots: BERKOL cots have been commonly used on the pre-spinning machine. BERKOL cots are standard specification of almost all the comber manufacturers. They also have a service station in China to remove and fit the rubber cover.

Question: What is your suggestion to Bräcker?

Mr. Zhao Zhihua: Since all spinners in China are going through a bad time due to the low margin, Bräcker should keep up the perfect quality and their excellent service.

Question: What is the outlook for 2016 and the future?

Mr. Zhao Zhihua: 2016 will be another difficult year with many uncertainties. Due to the viscose/rayon price increase, this will be a positive point for many spinning mills for the future. The spinning business will not expand too much, but will go for boutique (niche markets). Another trend is to invest more abroad.



Right: Zhao Zhihua, Vice General Manager, Spinning department 2

Left: Wang Fengping, Shanghai Sanshao Int. Trading Co., Ltd., Agent of Bräcker



A glance in a spinning plant of Dasheng Group

A close-up photograph of a metal comb with a fine-toothed edge. The comb is oriented vertically. Several vertical stripes of different colors are visible: a blue stripe on the left, a red stripe in the center, and a gold stripe on the right. The background is dark and out of focus.

Bräcker

Novibra

Suessen

Graf